

HIKVISION



Network Dome Camera

Quick Start Guide

UD05707B

Quick Start Guide

COPYRIGHT ©2017 Hangzhou Hikvision Digital Technology Co., Ltd.

ALL RIGHTS RESERVED.

Any and all information, including, among others, wordings, pictures, graphs are the properties of Hangzhou Hikvision Digital Technology Co., Ltd. or its subsidiaries (hereinafter referred to be “Hikvision”). This user manual (hereinafter referred to be “the Manual”) cannot be reproduced, changed, translated, or distributed, partially or wholly, by any means, without the prior written permission of Hikvision. Unless otherwise stipulated, Hikvision does not make any warranties, guarantees or representations, express or implied, regarding to the Manual.

About this Manual

This Manual is applicable to 4Dxx Network Camera.

The Manual includes instructions for using and managing the product. Pictures, charts, images and all other information hereinafter are for description and explanation only. The information contained in the Manual is subject to change, without notice, due to firmware updates or other reasons. Please find the latest version in the company website (<http://overseas.hikvision.com/en/>).

Please use this user manual under the guidance of professionals.

Trademarks Acknowledgement

HIKVISION and other Hikvision’s trademarks and logos are the properties of Hikvision in various jurisdictions. Other trademarks and logos mentioned below are the properties of their respective owners.

Legal Disclaimer

TO THE MAXIMUM EXTENT PERMITTED BY APPLICABLE LAW, THE PRODUCT DESCRIBED, WITH ITS HARDWARE, SOFTWARE AND FIRMWARE, IS PROVIDED "AS IS", WITH ALL FAULTS AND ERRORS, AND HIKVISION MAKES NO WARRANTIES, EXPRESS OR IMPLIED, INCLUDING WITHOUT LIMITATION, MERCHANTABILITY, SATISFACTORY QUALITY, FITNESS FOR A PARTICULAR PURPOSE, AND NON-INFRINGEMENT OF THIRD PARTY. IN NO EVENT WILL HIKVISION, ITS DIRECTORS, OFFICERS, EMPLOYEES, OR AGENTS BE LIABLE TO YOU FOR ANY SPECIAL, CONSEQUENTIAL, INCIDENTAL, OR INDIRECT DAMAGES, INCLUDING, AMONG OTHERS, DAMAGES FOR LOSS OF BUSINESS PROFITS, BUSINESS INTERRUPTION, OR LOSS OF DATA OR DOCUMENTATION, IN CONNECTION WITH THE USE OF THIS PRODUCT, EVEN IF HIKVISION HAS BEEN ADVISED OF THE POSSIBILITY OF SUCH DAMAGES.

SURVEILLANCE LAWS VARY BY JURISDICTION. PLEASE CHECK ALL RELEVANT LAWS IN YOUR JURISDICTION BEFORE USING THIS PRODUCT IN ORDER TO ENSURE THAT YOUR USE CONFORMS THE APPLICABLE LAW. HIKVISION SHALL NOT BE LIABLE IN THE EVENT THAT THIS PRODUCT IS USED WITH ILLEGITIMATE PURPOSES.

IN THE EVENT OF ANY CONFLICTS BETWEEN THIS MANUAL AND THE APPLICABLE LAW, THE LATER PREVAILS.

Regulatory Information

FCC Information

Please take attention that changes or modification not expressly approved by the party responsible for compliance could void the user's authority to operate the equipment.

FCC compliance: This equipment has been tested and found to comply with the limits for a Class B digital device, pursuant to part 15 of the FCC Rules. These limits are designed to provide reasonable protection against harmful interference in a residential installation. This equipment generates, uses and can radiate radio frequency energy and, if not installed and used in accordance with the instructions, may cause harmful interference to radio communications. However, there is no guarantee that interference will not occur in a particular installation. If this equipment does cause harmful interference to radio or television reception, which can be determined by turning the equipment off and on, the user is encouraged to try to correct the interference by one or more of the following measures:

- Reorient or relocate the receiving antenna.
- Increase the separation between the equipment and receiver.
- Connect the equipment into an outlet on a circuit different from that to which the receiver is connected.
- Consult the dealer or an experienced radio/TV technician for help.

FCC Conditions

This device complies with part 15 of the FCC Rules. Operation is subject to the following two conditions:

1. This device may not cause harmful interference.
2. This device must accept any interference received, including interference that may cause undesired operation.

EU Conformity Statement



This product and - if applicable - the supplied accessories too are marked with "CE" and comply therefore with the applicable harmonized European standards listed under the EMC Directive 2014/30/EU, the RoHS Directive 2011/65/EU.



2012/19/EU (WEEE directive): Products marked with this symbol cannot be disposed of as unsorted municipal waste in the European Union. For proper recycling, return this product to your local supplier upon the purchase of equivalent new equipment, or dispose of it at designated collection points. For more information see: www.recyclethis.info



2006/66/EC (battery directive): This product contains a battery that cannot be disposed of as unsorted municipal waste in the European Union. See the product documentation for specific battery information. The battery is marked with this symbol, which may include lettering to indicate cadmium (Cd), lead (Pb), or mercury (Hg). For proper recycling, return the battery to your supplier or to a designated collection point. For more information see: www.recyclethis.info

Industry Canada ICES-003 Compliance

This device meets the CAN ICES-3 (B)/NMB-3(B) standards requirements.



Safety Instruction

These instructions are intended to ensure that user can use the product correctly to avoid danger or property loss.

The precaution measure is divided into “Warnings” and “Cautions”

Warnings: Serious injury or death may occur if any of the warnings are neglected.

Cautions: Injury or equipment damage may occur if any of the cautions are neglected.

	
Warnings Follow these safeguards to prevent serious injury or death.	Cautions Follow these precautions to prevent potential injury or material damage.



Warnings

- Proper configuration of all passwords and other security settings is the responsibility of the installer and/or end-user.
- In the use of the product, you must be in strict compliance with the electrical safety regulations of the nation and region. Please refer to technical specifications for detailed information.
- Input voltage should meet both the SELV (Safety Extra Low Voltage) and the Limited Power Source with 24 VAC or 12 VDC according to the IEC60950-1 standard. Please refer to technical specifications for detailed information.
- Do not connect several devices to one power adapter as adapter overload may cause over-heating or a fire hazard.

- Please make sure that the plug is firmly connected to the power socket. When the product is mounted on wall or ceiling, the device shall be firmly fixed.
- If smoke, odor or noise rise from the device, turn off the power at once and unplug the power cable, and then please contact the service center.



Cautions

- Make sure the power supply voltage is correct before using the camera.
- Do not drop the camera or subject it to physical shock.
- Do not touch sensor modules with fingers. If cleaning is necessary, use clean cloth with a bit of ethanol and wipe it gently. If the camera will not be used for an extended period, please replace the lens cap to protect the sensor from dirt.
- Do not aim the camera at the sun or extra bright places. Blooming or smearing may occur otherwise (which is not a malfunction), and affect the endurance of sensor at the same time.
- The sensor may be burned out by a laser beam, so when any laser equipment is in using, make sure that the surface of sensor will not be exposed to the laser beam.
- Do not place the camera in extremely hot, cold (the operating temperature shall be $-30^{\circ}\text{C} \sim +60^{\circ}\text{C}$, or $-40^{\circ}\text{C} \sim +60^{\circ}\text{C}$ if the camera model has an “H” in its suffix), dusty or damp locations, and do not expose it to high electromagnetic radiation.

- To avoid heat accumulation, good ventilation is required for operating environment.
- Keep the camera away from liquid while in use.
- While in delivery, the camera shall be packed in its original packing, or packing of the same texture.
- Regular part replacement: a few parts (e.g. electrolytic capacitor) of the equipment shall be replaced regularly according to their average enduring time. The average time varies because of differences between operating environment and using history, so regular checking is recommended for all the users. Please contact with your dealer for more details.
- Improper use or replacement of the battery may result in hazard of explosion. Replace with the same or equivalent type only. Dispose of used batteries according to the instructions provided by the battery manufacturer.
- If the product does not work properly, please contact your dealer or the nearest service center. Never attempt to disassemble the camera yourself. (We shall not assume any responsibility for problems caused by unauthorized repair or maintenance.)

Table of Contents

1 Appearance Description	10
1.1 Components	11
1.2 Cables	12
2 Installation	15
2.1 Preparation	16
2.1.1 Disassembling	16
2.1.2 Memory Card Installation	17
2.2 Mounting	18
2.2.3 Ceiling Mounting	18
2.2.4 Wall Mounting	22
2.2.5 Pendant Mounting	25
2.3 Installation of Network Cable Water-proof Jacket (Optional)	28
2.4 Installation of Water-proof Tape (Optional)	30
3 Setting the Network Camera over the LAN	34
3.1 Wiring	34
3.2 Activating the Camera	35
3.2.1 Activation via Web Browser	35
3.2.2 Activation via SADP Software	36
3.3 Modifying the IP Address	38
4 Accessing via Web Browser	41
5 Operating via Hik-Connect App	43
5.1 Enable Hik-Connect Service on Camera	43
5.1.1 Enable Hik-Connect Service via SADP Software ...	43
5.1.2 Enable Hik-Connect Service via Web Browser	44
5.2 Hik-Connect Setup	46

5.3 Adding Camera to Hik-Connect	46
5.4 Initializing the Memory Card	48

1 Appearance Description

The camera series has two appearance types:

Type I: Non-IK10 Camera

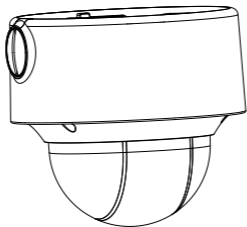

Figure 1-1 Type I Camera

Type II: IK10 Camera

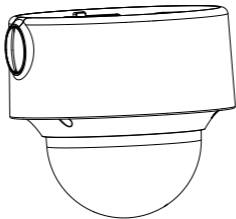

Figure 1-2 Type II Camera

1.1 Components

Two appearance types share similar structure except for the bubble.

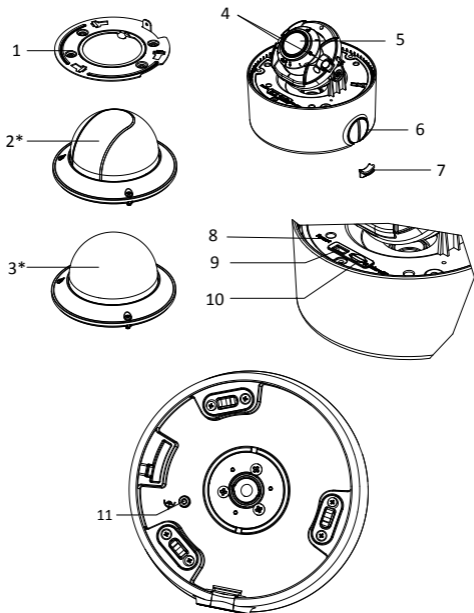

Figure 1-3 Camera Components

Table 1-1 Description of Camera Components

No.	Description	No.	Description
1	Mounting base	2*	Bubble for non-IK10 model
3*	Bubble for IK10 model	4	IR
5	Lens	6	Water-proof plug
7	Side outlet cover	8	Reset button
9	Serial port	10	Memory card slot
11	GND		

Note:

Press RESET for about 10s when the camera is powering on or rebooting to restore the default settings, including the user name, password, IP address, port No., etc.

1.2 Cables

This camera series has several camera models, each of which may have different cable group. The following figures and tables show the description of possible cables in this camera series.

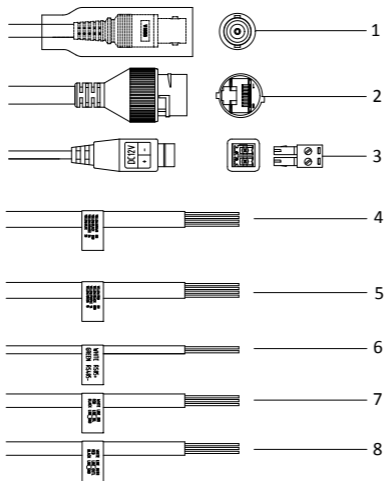

Figure 1-4 Overview of Cables

Table 1-2 Description of Cables

No.	Description
1	BNC cable and interface
2	10M/100M self-adaptive Ethernet cable and RJ45 interface (PoE supported)
3	Power supply cable and terminal block interface

Network Dome Camera • Quick Start Guide

No.	Description		
4	No.2 alarm input/output cable	Alarm input	IN2: yellow/brown
			GND: yellow/black
		Alarm output	2A: yellow/orange
			2B: yellow/blue
5	No.1 alarm input/output cable	Alarm input	IN1: yellow/red
			GND: yellow/black
		Alarm output	1A: yellow/purple
			1B: yellow/green
6	RS485 cable	RS485+: white	
		RS485-: green	
7	Audio input cable	INR: white	
		INL: red	
		GND: black	
8	Audio output cable	OUTR:	
		OUTL: red	
		GND: black	

2 Installation

Before you start:

- Make sure the device in the package is in good condition and all the assembly parts are included.
- The standard power supply is 12 VDC or 24 VAC, please make sure your power supply matches with your camera.
- Make sure all the related equipment is power-off during the installation.
- Check the specification of the products for the installation environment.
- Make sure that the wall is strong enough to withstand four times the weight of the camera and the bracket.

For the camera that supports IR, you are required to pay attention to the following precautions to prevent IR reflection:

- Dust or grease on the bubble will cause IR reflection. If there is dust or grease on the bubble, clean it with clean soft cloth and isopropyl alcohol.
- Make sure that there is no reflective surface too close to the camera lens. The IR light from the camera may reflect back into the lens causing reflection.

Notes:

- Do NOT peel off protective film on bubble and on lens before finishing camera installation.
- Type I camera and type II camera share similar installation steps. We take type I camera as example for demonstration.

2.1 Preparation

Purpose:

Before mounting, you have to disassemble the camera and install the memory card first.

2.1.1 Disassembling

Steps:

1. Loosen the three screws on the edge of the bubble with the screw driver.
2. Lift and put aside the bubble to disassemble the camera.

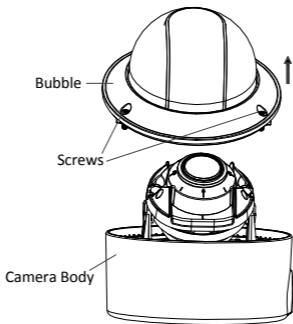

Figure 2-1 Remove the Bubble

2.1.2 Memory Card Installation

Steps:

1. Rotate the camera body to completely expose the memory card slot.
2. Insert the memory card into the memory card slot, and push it to get it mounted.

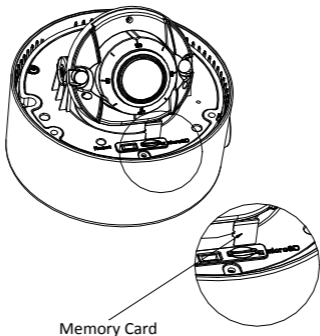

Figure 2-2 Install the Memory Card

3. (Optional) To unmount the memory card, push to eject it.

2.2 Mounting

2.2.3 Ceiling Mounting

1. Attach the supplied drill template to the place where you want to fix the camera.
2. Drill the screw holes and the cable hole according to the drill template as the figure below.

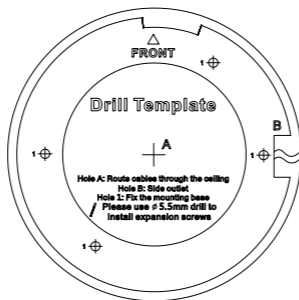

Figure 2-3 Drill Template

Notes:

- The drill template varies according to the different camera model.
- (Optional) Routing the cable from the side outlet instead of the cable hole drilled on the ceiling is supported.

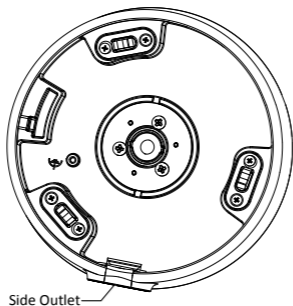

Figure 2-4 Side Outlet

3. Fix the mounting base to the ceiling with the supplied screws.

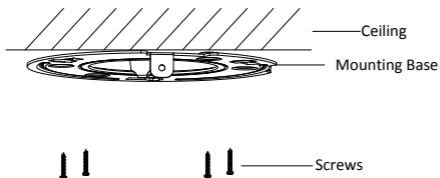

Figure 2-5 Install the Mounting Base

4. Align the camera body with the mounting base and rotate the camera body counterclockwise to get it fitted with the mounting base.

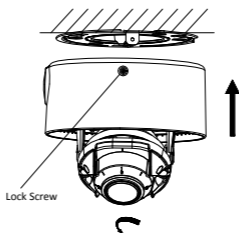

Figure 2-6 Install the Camera Body

5. Connect the video output connector to the monitor and connect the power connector to the power supply to adjust the surveillance angle and image.
6. Adjust the surveillance angle and image according to the figures below.
 - 1). 3-axis Adjustment

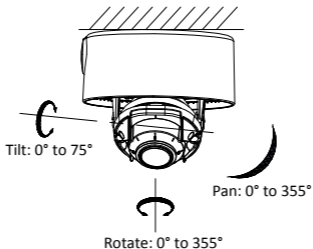

Figure 2-7 3-axis Adjustment

2). Zoom and Focus Adjustment

Cameras of this series are equipped with a motor-driven lens. You can adjust the zoom and focus level on PTZ control panel by visiting the camera via web browser or client software.

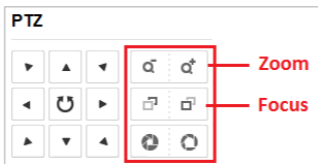

Figure 2-8 Zoom and Focus Adjustment via Web Browser

7. Attach the bubble to the camera body. Fix it with screwdriver to get tightened as the figures below.

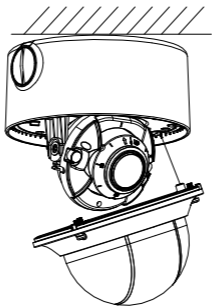

Figure 2-9 Install the Bubble

8. Tighten the lock screw to complete the installation.

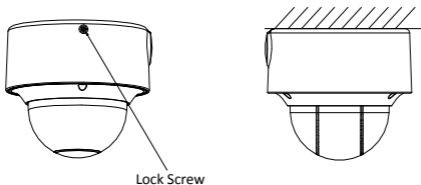

Figure 2-10 Complete the Installation

2.2.4 Wall Mounting

Before you start:

Wall mounting bracket is not included in package. If you choose this mounting type, you have to prepare a bracket first. The wall mounting bracket shown below is only for demonstration.

Note:

When choosing a wall mounting bracket, you must pay attention to the size of the cap which should match the mounting base of the camera.

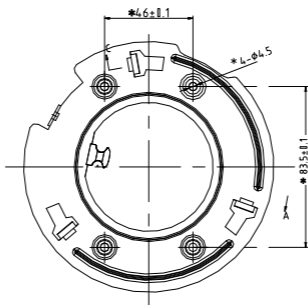

Figure 2-11 Size of the Mounting Base

Steps:

1. Route the cables, install the wall mounting bracket, and secure the cap on the bracket.

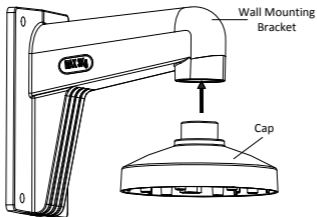

Figure 2-12 Install Wall Mounting Bracket

2. Align the screw holes of the mounting base with the corresponding screw holes of the cap.

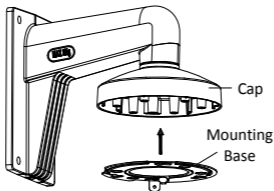

Figure 2-13 Install the Mounting Base

3. Secure the mounting base to the cap with screws.
4. Align the camera with the mounting base, and secure the camera with screws.

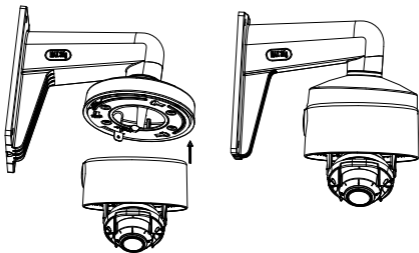

Figure 2-14 Secure the Camera

5. Connect the video output connector to the monitor and connect the power connector to the power supply to adjust the surveillance angle and image.
6. Adjust the image and focus. Please refer to step 6 in section 2.2.3 for more detailed information.
7. Install the bubble back to the camera and tighten the lock screw to complete the installation. Please refer to step 7 and step 8 in section 2.2.3 for more detailed information.

2.2.5 Pendant Mounting

Before you start:

Pendant mounting bracket is not included in package. If you choose this mounting type, you have to prepare a bracket first. The pendant mounting bracket shown below is only for demonstration.

Note:

When choosing a pendant mounting bracket, you must pay attention to the size of the cap which should match the mounting base of the camera.

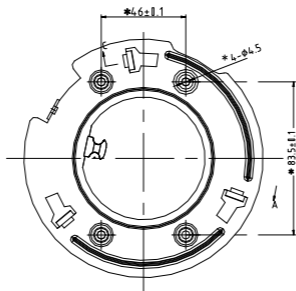

Figure 2-15 Size of the Mounting Base

Steps:

1. Route the cables and install the pendant mounting bracket. Secure the cap on the bracket.

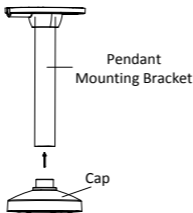

Figure 2-16 Install the Pendant Mounting Bracket

2. Align the screw holes of the mounting base with the corresponding screw holes of the cap.

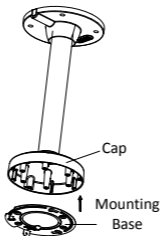

Figure 2-17 Install the Mounting Base

3. Secure the mounting base to the cap with screws.
4. Align the camera with the mounting base, and secure the camera with screws.

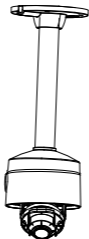

Figure 2-18 Secure the Camera

5. Connect the video output connector to the monitor and connect the power connector to the power supply to adjust the surveillance angle and image.
6. Adjust the image and focus. Please refer to step 6 in section 2.2.3 for more detailed information.
7. Install the bubble back to the camera and tighten the lock screw to complete the installation. Please refer to step 7 and step 8 in section 2.2.3 for more detailed information.

2.3 Installation of Network Cable Water-proof Jacket (Optional)

Purpose:

If the camera is installed outdoor, you can adapt the water-proof accessory for the network cable after the camera is secured on the installation surface.

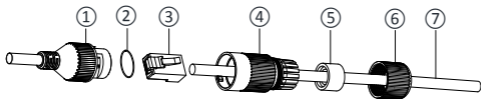

Figure 2-19 Water-proof Accessory Components

Table 2-1 Components

No.	Components
1	Camera's Network Interface Socket

Network Dome Camera • Quick Start Guide

No.	Components
2	O-Type Gasket
3	Network Plug
4	Waterproof Endcap
5	Waterproof Rubber Gasket
6	Lock Nut
7	Network Cable from Router/Switch

Steps:

1. Feed the plugless network cable (7) through the lock nut (6), waterproof rubber gasket (5) (the rubber gasket inset ridge must face the waterproof endcap), and the waterproof endcap (4) in order.
2. Crimp an RJ-45 network plug (3) onto the end of the cable, taking care to insert the twisted pairs of wires in correct order.
3. Place the O-type gasket (2) onto the end of the camera's network interface socket (1).
4. Insert the network plug (3) into the camera's network interface socket (1).
5. Insert the waterproof rubber gasket (5) into the waterproof endcap (4), and secure lock nut (6) with the waterproof endcap (4).
6. Align the snap on the waterproof endcap (4) with the notch on the camera's network interface socket (1), and then secure the

waterproof endcap ④ to the camera's network interface socket ① to finish installation.

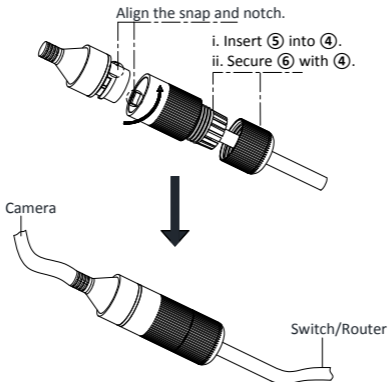

Figure 2-20 Water-proof Accessory Installation

2.4 Installation of Water-proof Tape (Optional)

Purpose:

If the camera is installed outdoor, you can use supplied water-proof tape to protect cable connectors and unused cables after the camera is secured on the installation surface.

Steps:

1. Tear off the yellow release paper on the back of the water-proof tape.
2. Stretch the water-proof tape to reach twice the initial length.

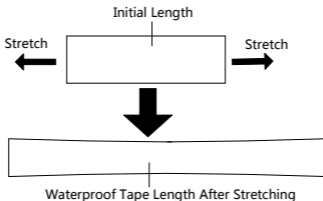

Figure 2-21 Stretch the Water-proof Tape

3. Wrap the water-proof tape around the cable connector tightly as the figure below.

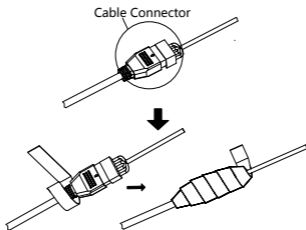

Figure 2-22 Wrap the Water-proof Tape

Note:

Make sure that all naked wires are all firmly wrapped in the water-proof tape.

4. Press the tape on both ends of the connector to make sure no water can get in as the figure below.

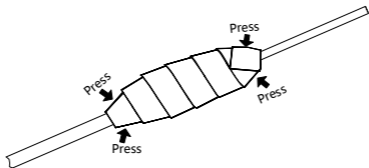

Figure 2-23 Press the Water-proof Tape

5. Wrap the water-proof tape around the remaining unused cables tightly as the figure below.

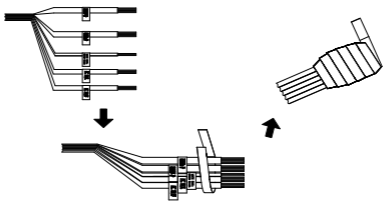

Figure 2-24 Wrap the Water-proof Tape

Note:

Make sure that all naked wires are all firmly wrapped in the water-proof tape.

6. Press the tape to make sure no water can get in as the figure below.

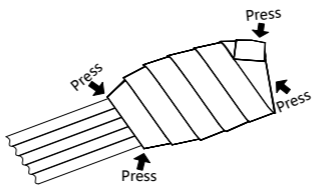

Figure 2-25 Press the Water-proof Tape

3 Setting the Network Camera over the LAN

Note:

You shall acknowledge that the use of the product with Internet access might be under network security risks. For avoidance of any network attacks and information leakage, please strengthen your own protection.

If the product does not work properly, contact your dealer or the nearest service center for help.

3.1 Wiring

Connect the camera to network according to the following figures.

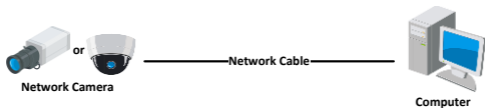

Figure 3-1 Connecting Directly

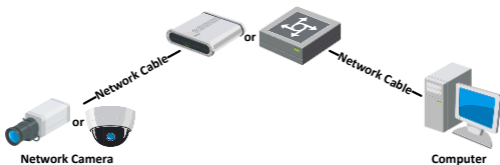

Figure 3-2 Connecting via a Switch or a Router

3.2 Activating the Camera

You are required to activate the camera first by setting a strong password for it before you can use the camera.

Activation via Web Browser, Activation via SADP, and Activation via Client Software are all supported. We will take activation via SADP software and Activation via Web Browser as examples to introduce the camera activation.

Note:

Refer to the User Manual of Network Camera for Activation via Client Software.

3.2.1 Activation via Web Browser

Steps:

1. Power on the camera. Connect the camera to your computer or the switch/router which your computer connects to.
2. Input the IP address into the address bar of the web browser, and press Enter to enter the activation interface.

Notes:

- The default IP address of the camera is 192.168.1.64.
- The computer and the camera should belong to the same subnet.
- For the camera enables the DHCP by default, you need to use the SADP software to search the IP address.

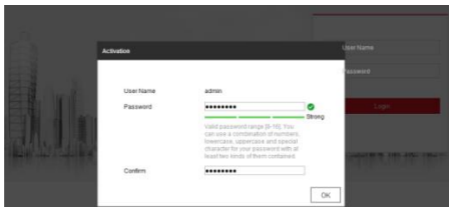

Figure 3-3 Activation Interface(Web)

3. Create a password and input the password into the password field.



STRONG PASSWORD RECOMMENDED– *We highly recommend you create a strong password of your own choosing (using a minimum of 8 characters, including upper case letters, lower case letters, numbers, and special characters) in order to increase the security of your product. And we recommend you reset your password regularly, especially in the high security system, resetting the password monthly or weekly can better protect your product.*

4. Confirm the password.
5. Click **OK** to save the password and enter the live view interface.

3.2.2 Activation via SADP Software

SADP software is used for detecting the online device, activating the camera, and resetting the password.



STRONG PASSWORD RECOMMENDED– *We highly recommend you create a strong password of your own choosing (using a minimum of 8 characters, including upper case letters, lower case letters, numbers, and special characters) in order to increase the security of your product. And we recommend you reset your password regularly, especially in the high security system, resetting the password monthly or weekly can better protect your product.*

Note:

You can enable the Hik-Connect service for the device during activation. Refer to Chapter 5.1 for detailed information.

4. Click **Activate** to start activation.

You can check whether the activation is completed on the popup window. If activation failed, make sure that the password meets the requirement and try again.

3.3 Modifying the IP Address

Purpose:

To view and configure the camera via LAN (Local Area Network), you need to connect the network camera in the same subnet with your PC.

Use the SADP software or client software to search and change the IP address of the device. We take modifying the IP Address via SADP software as an example to introduce the IP address modification.

For IP address modification via client software, refer to the user manual of client software.

Steps:

1. Run the SADP software.
2. Select an active device.
3. Change the device IP address to the same subnet with your computer by either modifying the IP address manually or checking the checkbox of Enable DHCP.

Modify Network Parameters

Enable DHCP
 Enable Hik-Connect

Device Serial No.:

IP Address:

Port:

Subnet Mask:

Gateway:

IPv6 Address:

IPv6 Gateway:

IPv6 Prefix Length:

HTTP Port:

----- Security Verification -----

Admin Password:

Modify

[Forgot Password](#)

Figure 3-5 Modify the IP Address

Note:

You can enable the Hik-Connect service for the device during activation. Refer to Chapter 5.1 for detailed information.

4. Input the admin password and click **Modify** to activate your IP address modification.

The batch IP address modification is supported by the SADP. Refer to the user manual of SADP for details.

4 Accessing via Web Browser

System Requirement:

Operating System: Microsoft Windows XP SP1 and above version

CPU: 2.0 GHz or higher

RAM: 1G or higher

Display: 1024×768 resolution or higher

Web Browser: Internet Explorer 8.0 and above version, Apple Safari 5.0.2 and above version, Mozilla Firefox 5.0 and above version and Google Chrome 18 and above version

Steps:

1. Open the web browser.
2. In the browser address bar, input the IP address of the network camera, and press the **Enter** key to enter the login interface.

Note:

- The default IP address is 192.168.1.64. You are recommended to change the IP address to the same subnet with your computer.

3. Input the user name and password.

The admin user should configure the device accounts and user/operator permissions properly. Delete the unnecessary accounts and user/operator permissions.

Note:

The device IP address gets locked if the admin user performs 7 failed password attempts (5 attempts for the user/operator).

4. Click **Login**.



Figure 4-1 Login Interface

5. Install the plug-in before viewing the live video and managing the camera. Follow the installation prompts to install the plug-in.

Note:

You may have to close the web browser to finish the installation of the plug-in.

[Please click here to download and install the plug-in. Close the browser when installing the plug-in.](#)

Figure 4-2 Download Plug-in

6. Reopen the web browser after the installation of the plug-in and repeat steps 2 to 4 to login.

Note:

For detailed instructions of further configuration, please refer to the user manual of network camera.

5 Operating via Hik-Connect App

Purpose:

Hik-Connect is an application for mobile devices. With the App, you can view live image of the camera, receive alarm notification and so on.

Note:

Hik-Connect service is not supported by certain camera models.

5.1 Enable Hik-Connect Service on Camera

Purpose:

Hik-Connect service should be enabled on your camera before using the service.

You can enable the service through SADP software or web browser.

5.1.1 Enable Hik-Connect Service via SADP Software

Steps:

1. Check the checkbox of **Enable Hik-Connect** on:
 - 1). "Activate the Device" page during camera activation, refer to Chapter 3.2.2.
 - 2). Or "Modify Network Parameters" page during modifying IP address, refer to Chapter 3.3.
2. Create a verification code or change the verification code.

The screenshot shows a 'Tips' dialog box with a red header and a close button. The main text reads: 'To enable Hik-Connect service, you need to create a verification code or change the verification code.' Below this, there are two input fields: 'Verification Code' and 'Confirm Verification Code', both containing six dots. To the right of the first field, instructions state: '6 to 12 letters or numbers, case sensitive. You are recommended to use a combination of no less than 8 letters or numbers.' At the bottom, there is a note: 'The Hik-Connect service will require internet access. Please read the ["Terms of Service"](#) and ["Privacy Policy"](#) before enabling the service.' At the bottom right, there are two buttons: 'Confirm' (red) and 'Cancel' (white).

Figure 5-1 Verification Code Setting (SADP)

Note:

The verification code is required when you add the camera to Hik-Connect app.

3. Click and read "Terms of Service" and "Privacy Policy".
4. Confirm the settings.

5.1.2 Enable Hik-Connect Service via Web Browser

Before you start:

You need to activate the camera before enabling the service. Refer to Chapter 3.2.

Steps:

1. Access the camera via web browser. Refer to Chapter 4.
2. Enter platform access configuration interface: Configuration > Network > Advanced Settings > Platform Access

Enable

Platform Access Mode

Server IP Custom

Register Status

Verification Code

6 to 12 letters (a to z, A to Z) or numbers (0 to 9), case sensitive. You are recommended to use

Figure 5-2 Platform Access Configuration (Web)

3. Select Platform Access Mode as Hik-Connect.
4. Check the checkbox of Enable.
5. Click and read "Terms of Service" and "Privacy Policy" in pop-up window.
6. Create a verification code or change the verification code for the camera.

Note:

The verification code is required when you add the camera to Hik-Connect app.

7. Save the settings.

5.2 Hik-Connect Setup

Steps:

1. Download and install the Hik-Connect app by searching “Hik-Connect” in App Store or Google Play™.
2. Launch the app and register for a Hik-Connect user account.
3. Log in Hik-Connect app after registration.

5.3 Adding Camera to Hik-Connect

Before you start:

You need to enable the Hik-Connect service on camera before adding it to your Hik-Connect account. Refer to Chapter 5.1.

Steps:

1. Use a network cable to connect the camera with a router if the camera does not support Wi-Fi.



Figure 5-3 Connect a Router

Note:

After the camera connects to the network, please wait one minute before any operation on the camera using Hik-Connect app.

2. In the Hik-Connect app, tap “+” on the upper-right corner and then scan the QR code of the camera to add the camera.

You can find the QR code on the camera or on the cover of the Quick Start Guide of the camera in the package.

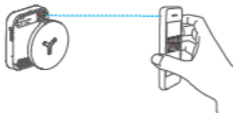



Figure 5-4 Scan QR Code

Note:

If the QR code is missing or too blur to be recognized, you can also add the camera by tapping the  icon and inputting the camera's serial number.

3. Input the verification code of your camera.

Note:

- The required verification code is the code you create or change when you enabling Hik-Connect service on camera.
- If you forget the verification code, you can check the current verification code on **Platform Access** configuration page via web browser.

4. Follow the prompts to set the network connection and add the camera to your Hik-Connect account.

Note:

For detailed information, refer to the user manual of the Hik-Connect app.

5.4 Initializing the Memory Card

Steps:

Check the memory card status by tapping on the Storage Status in the Device Settings interface.

If the memory card status displays as Uninitialized, tap to initialize it. The status will then change to Normal. You can then start recording any event triggered video in the camera such as motion detection.



First Choice for Security Professionals